



g.tec medical engineering GmbH
4521 Schiedlberg, Sierningstrasse 14, Austria

Tel.: (43)-7251-22240-0

Fax: (43)-7251-22240-39

office@gtec.at, <http://www.gtec.at>



**P300 Spelling Device with
g.MOBIIlab+ and Simulink
v3.12.03**

Copyright 2012 g.tec medical engineering GmbH

Introduction

g.MOBILab+ is a biosignal acquisition system for EEG, ECG, EMG, EOG and other sensors. In this tutorial the usage of the device for a P300 spelling device will be shown. With a MATLAB S-function a paradigm was implemented that presents characters on the computer screen. The single characters flash in a random order sequentially. Therefore the name Single Character Flash Speller is used within this tutorial. A free spelling and a copy spelling mode were implemented. The free spelling mode allows to write words without instructions, the copy spelling mode allows to spell words which are previously defined. The Simulink Highspeed On-line Processing blockset allows to read in data into Simulink in real-time and to perform the parameter estimation and classification. No additional compilation of the Simulink model is required for the on-line processing.

Required Components

To perform the tutorial the following components are required:

- **g.MOBILab+** biosignal acquisition device
- **Simulink Highspeed On-line Processing** blocks for g.MOBILab+
- **g.BSanalyze** off-line processing toolbox
- EEG electrodes and an EEG cap
- PC or notebook with serial or USB connector
- MATLAB and Simulink Release 2012a

Quickstart

The corresponding Simulink model can be started from the MATLAB **Start** button:

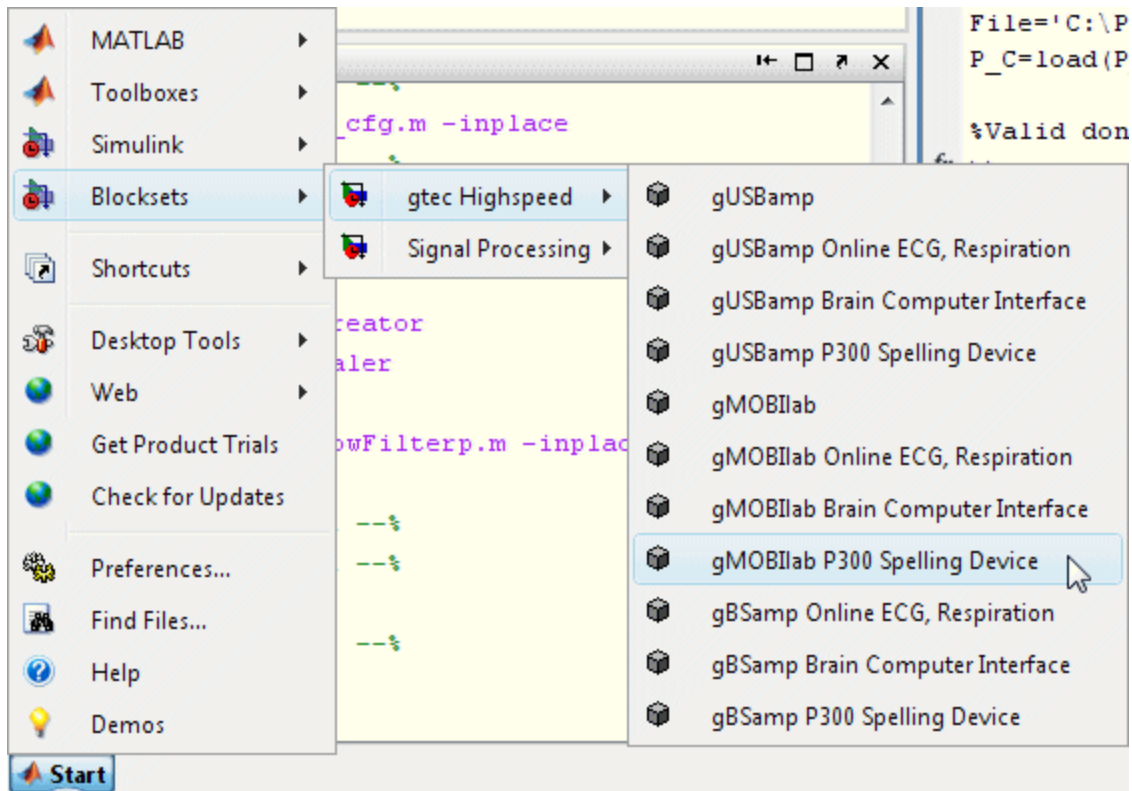

or by typing `gMOBILabplusP300SCF` into the MATLAB command line.

The following Simulink model opens:

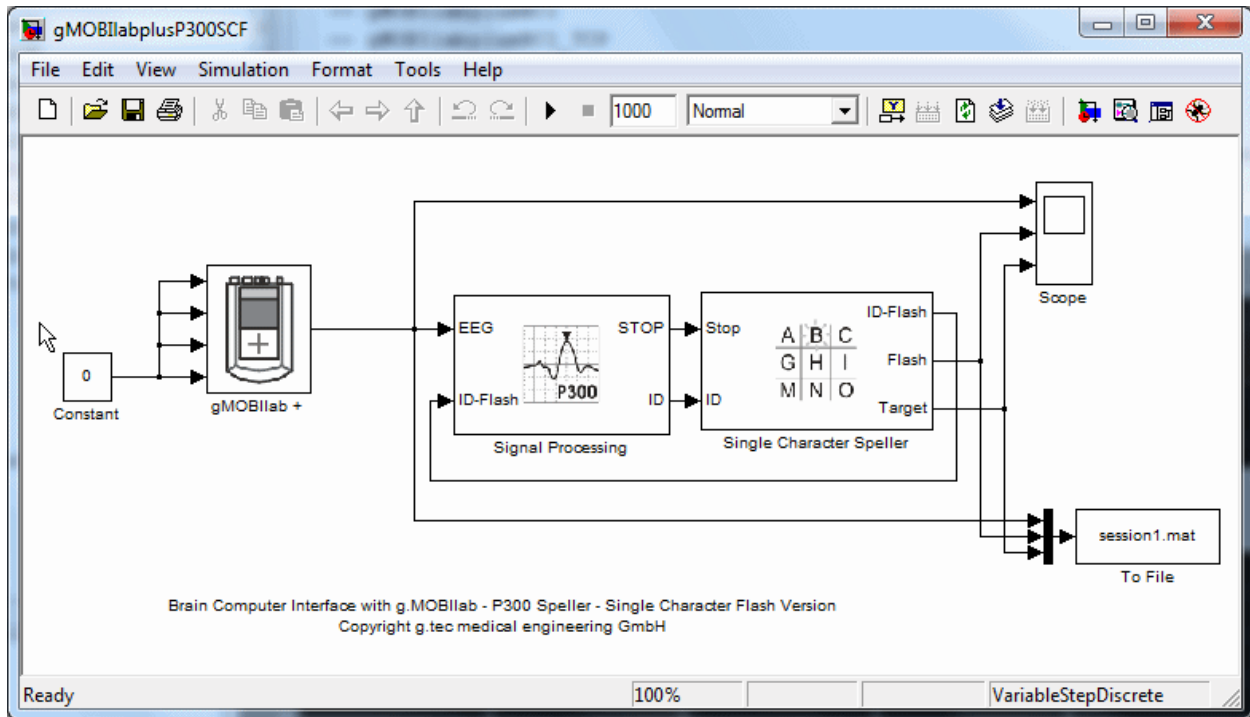

Driver configuration

Double click onto the **g.MOBILab+** block to open the following window:

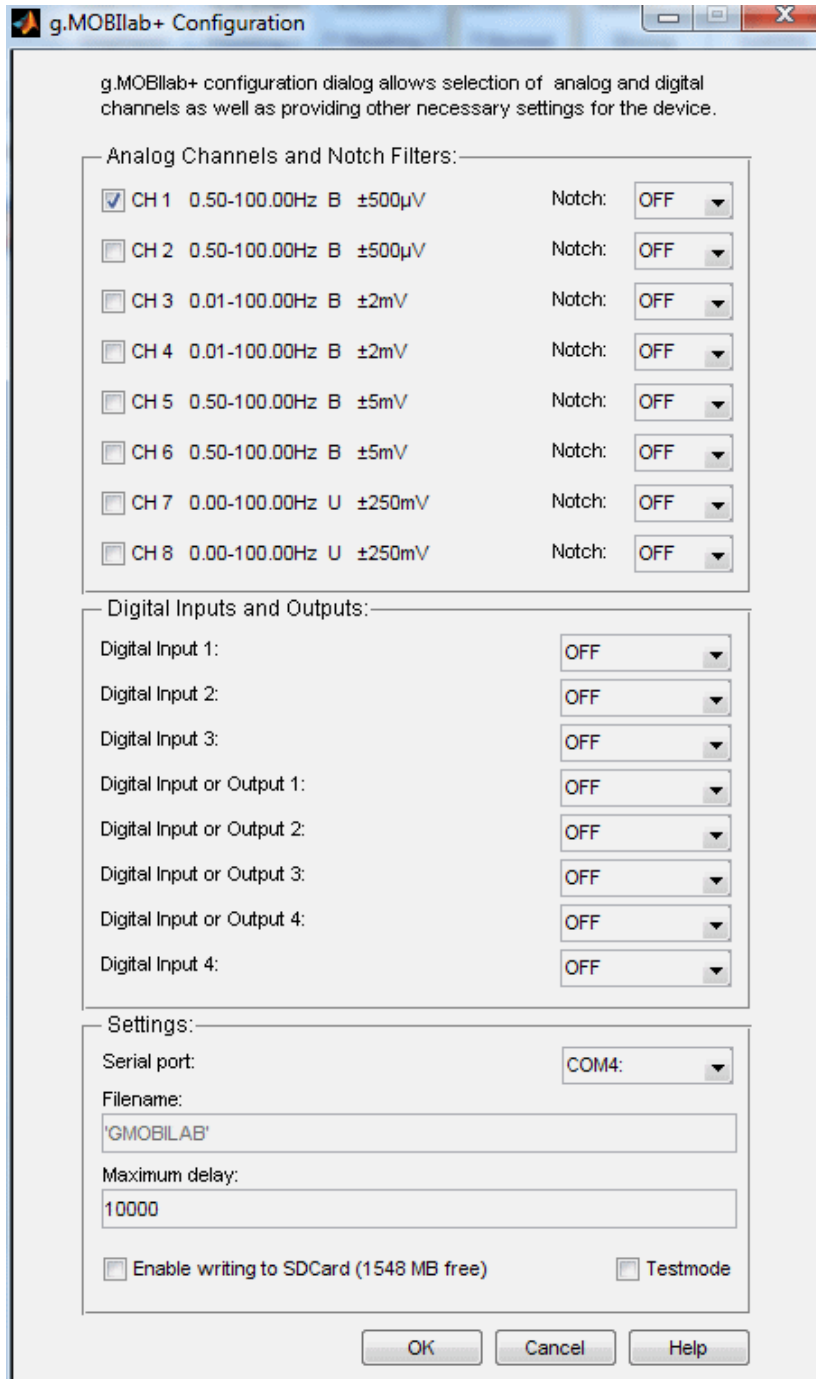

Select only Analog Channel 1. Deselect all digital channels by setting them **OFF**. Select the **Serial port** where g.MOBILab+ is connected (e.g. COM4:).

Now g.MOBILab+ is correctly initialized. Press **OK** to accept the settings and to close the window.

Signal processing

The Simulink model performs a P300 analysis. Therefore the **Signal Processing** block receives the EEG data with 256 Hz. First this data is down-sampled by averaging 4 samples to 64 Hz. As soon as the **Signal-Processing** block receives an input on **ID-Flash** it begins to fill the first buffer with EEG data. The **ID-Flash** indicates the time point when a letter is flashing up on the computer screen and is controlled by the block **Single Character Speller**. **ID-Flash** must be an integer. If another **ID-Flash** with the same number occurs again the EEG data is transferred to the first buffer. If **ID-Flash** contains another number a new buffer is generated and filled with EEG data. Therefore the **Signal Processing** block fills as many buffers (N) as different **ID-Flash** numbers occur.

The **Buffer length** is determined by double-clicking onto the **Signal Processing** block.

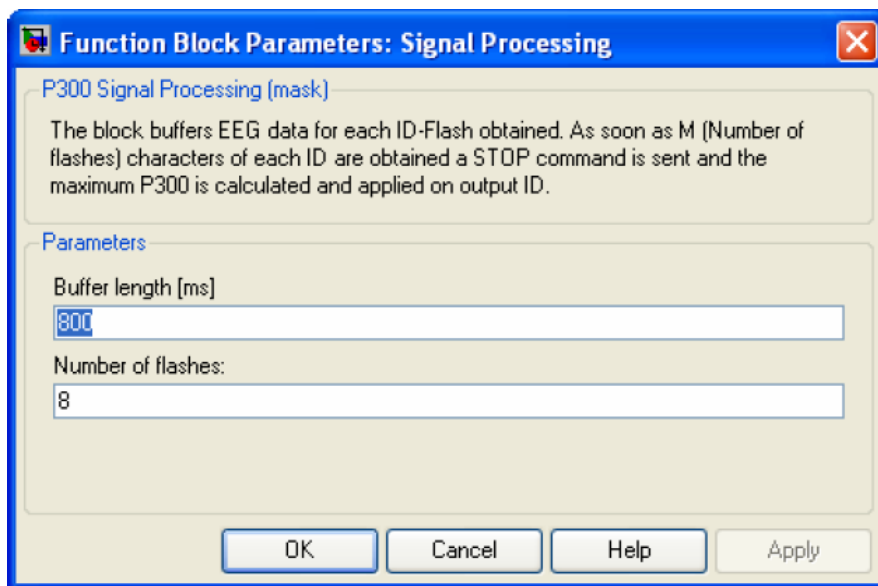

A **Buffer length** of 800 ms stores the EEG data 100 ms before the **ID-Flash** occurs and 700 ms afterwards. The **Number of flashes** is set e.g. to 8. Therefore the **Signal Processing** block waits as long as each **Flash-ID** occurred 8 times. Then the block sends a **STOP** command to the **Single Character Speller** block. This causes the interruption of the paradigm. The **Signal Processing** block keeps on filling up the last buffer until the 800 ms EEG data are stored. Then the classification is performed.

Now each of the N buffers with 800 ms length is averaged over the 8 flashes. This yields to N different averages called P300 potentials. Now the classification algorithm looks for the maximum P300 of all N buffers. The ID of this buffer is sent via output **ID** to the **Single Character Speller**. Then the paradigm displays the character identified by the **Signal Processing** unit.

Paradigm

The subject has to be seated one meter in front of the computer screen. Instruct the subject to sit relaxed on a comfortable arm chair. Mount one electrode on electrode position Cz, the reference on the right mastoid or ear lobe and the ground on the forehead. Ensure that the electrode impedance is below 10 kOhm.

The output of the **Signal Processing** block is connected to the **Single Character Speller** block. This is a MATLAB S-function which controls the experimental paradigm.

Double click on the block to open the following window:

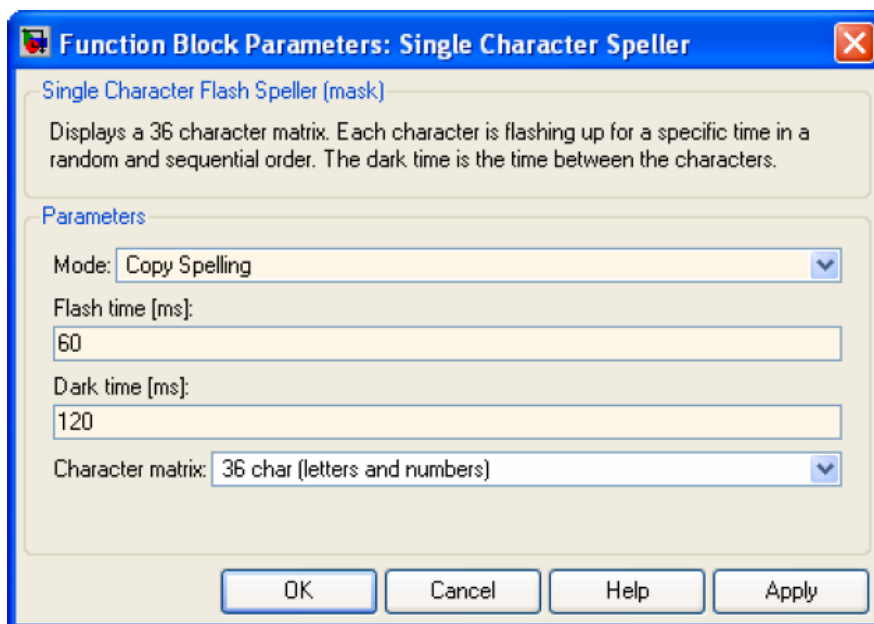

The window allows to select between two modes: (i) Copy spelling and (ii) Free spelling.

Flash time defines for how many ms the character is highlighted on the screen.

Dark time defines the time between two flashes in ms.

Under **Character matrix** 36 characters (letters and numbers) or only 26 characters (letters) can be selected. The paradigm will show a 36 character matrix containing the letters A, B, ...Z and the number 1, 2, ...9 as well as a space symbol in form of an underline or only 26 characters consisting of letters only.

Each of the letters will flash up for a certain time in a random and sequential order. The task of the subject is to look at a specific letter and to count as fast as possible how many times the specific letter is flashing up. Each character is flashing up for M times. M can be selected and

should be between 2 and 20 depending on the skills of your subject. If $M=20$ then each character is flashing up 20 times and all 20 flashes are averaged to calculate the P300. The accuracy will be higher with a higher M , but also the spelling time of a single character will increase. Therefore the goal is to reach with training a very small M value.

(1) COPY SPELLING

Select Copy Spelling and close the window.

Then double click onto the **To File** block:

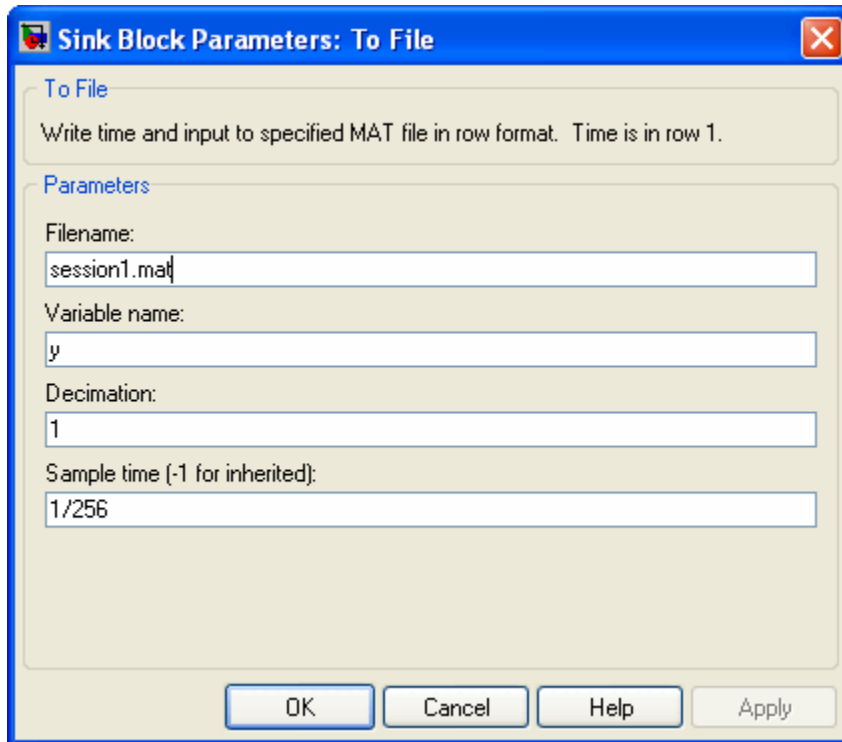

Enter under **Filename** session1.mat and under **Variable Name** y. This stores the data into matrix y.

Press **OK** to close the window.

Start the P300 paradigm in the Simulink model menu.



The copy spelling mode allows to enter letters that should be copied during the experiment.

Enter BCI by clicking onto the characters:

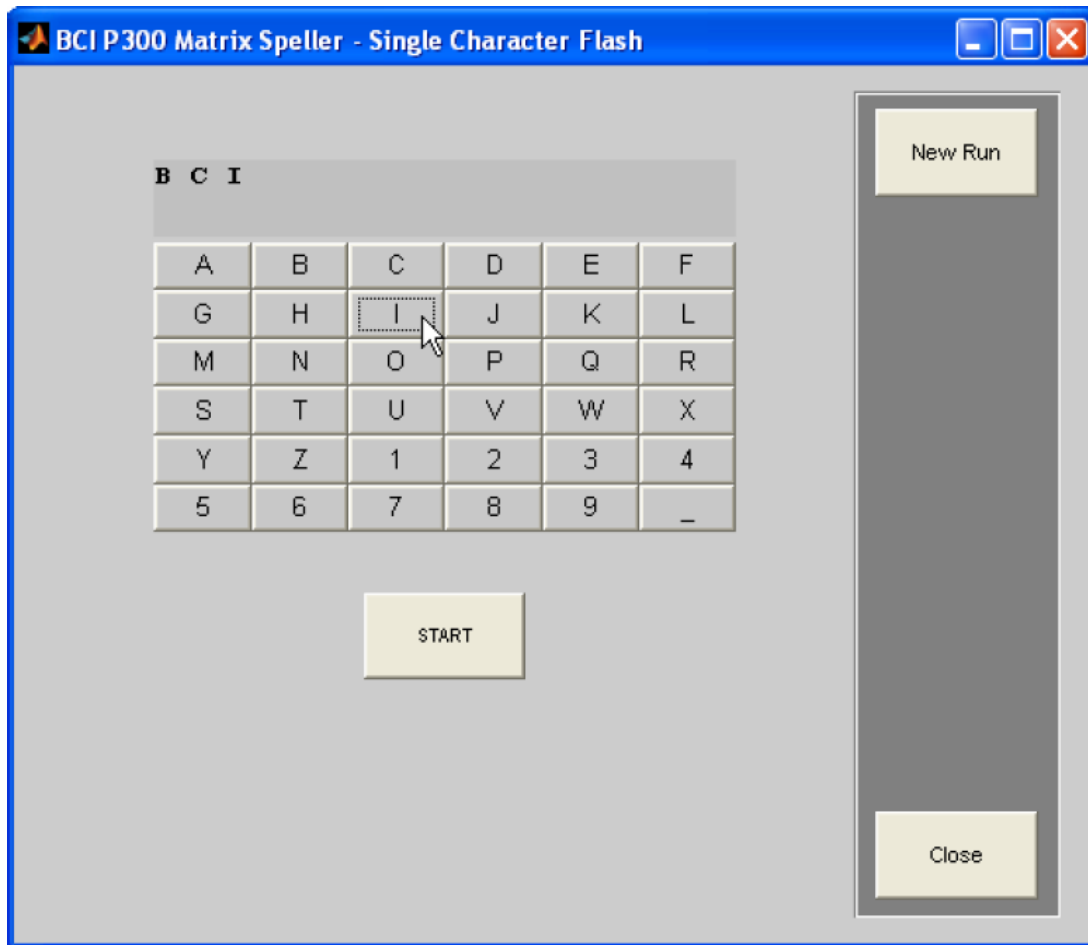

Then press **START** to begin the experiment.

Each character is flashing up for 60 ms. The **Single Character Speller** block sends the ID of the character which is flashing up to the **Signal Processing** block, to the **Scope** and to the **To File** block.

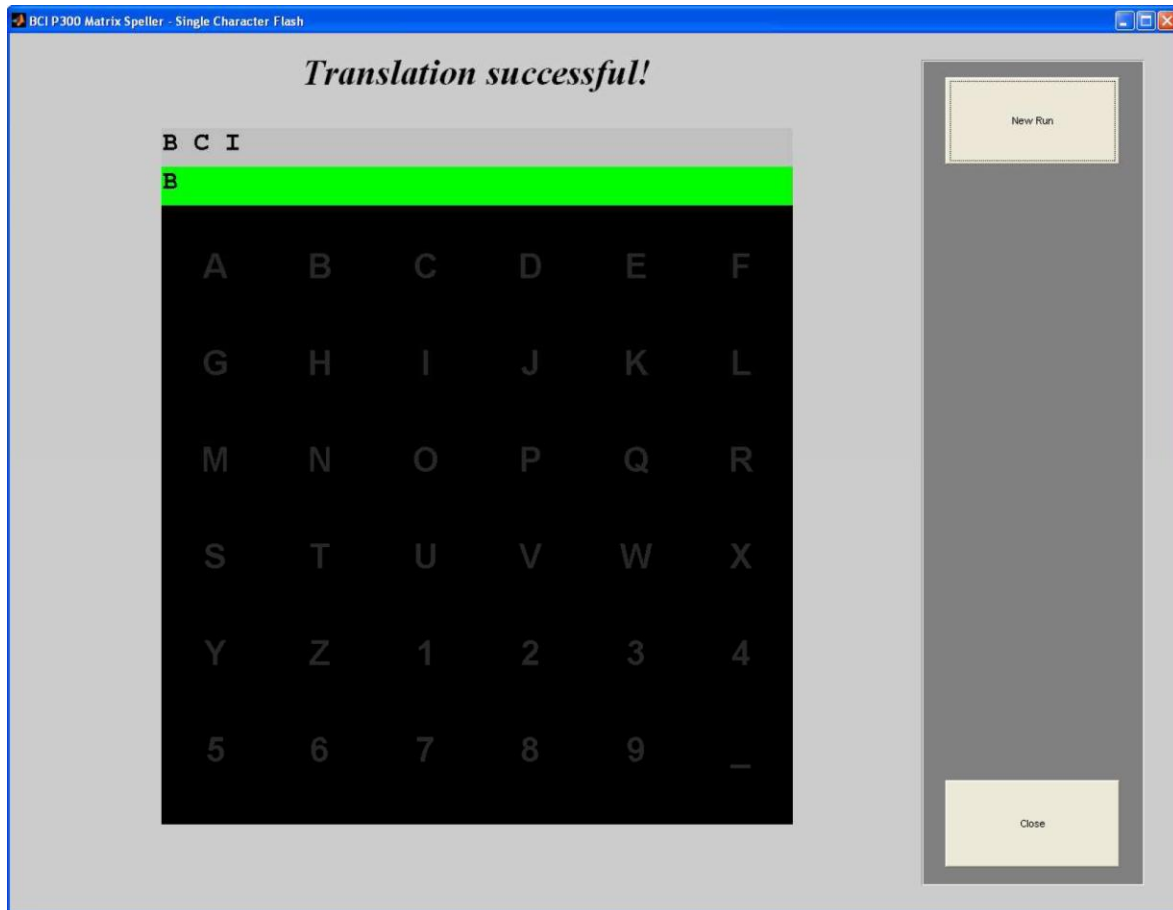

When the **Signal Processing** sends the **STOP** command the paradigm stops and waits for the decision of the parameter extraction and classification. Then the selected character is displayed in the second line of the paradigm window.

Finally the paradigm window displays the achieved accuracy:

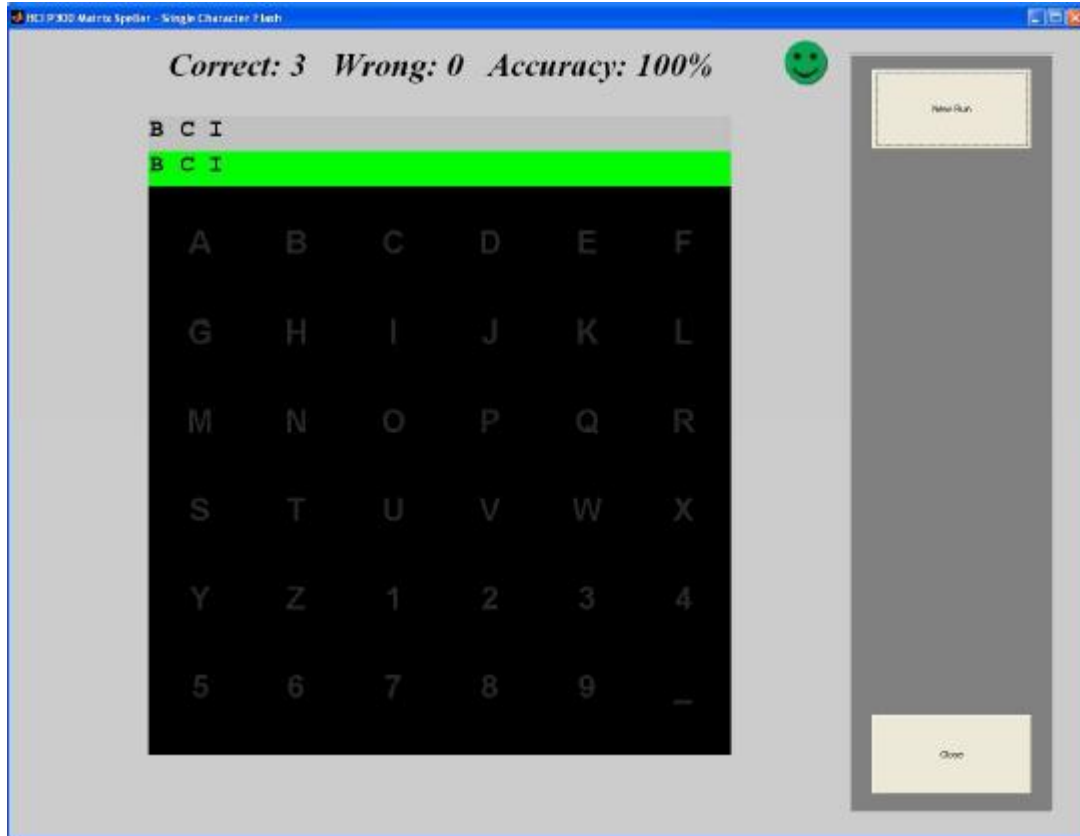

Close the window and **Stop** the Simulink model:



(II) Free Spelling

Now select the Free Spelling, enter into the **To File** block yourfilename.mat and **Start** the Simulink model.

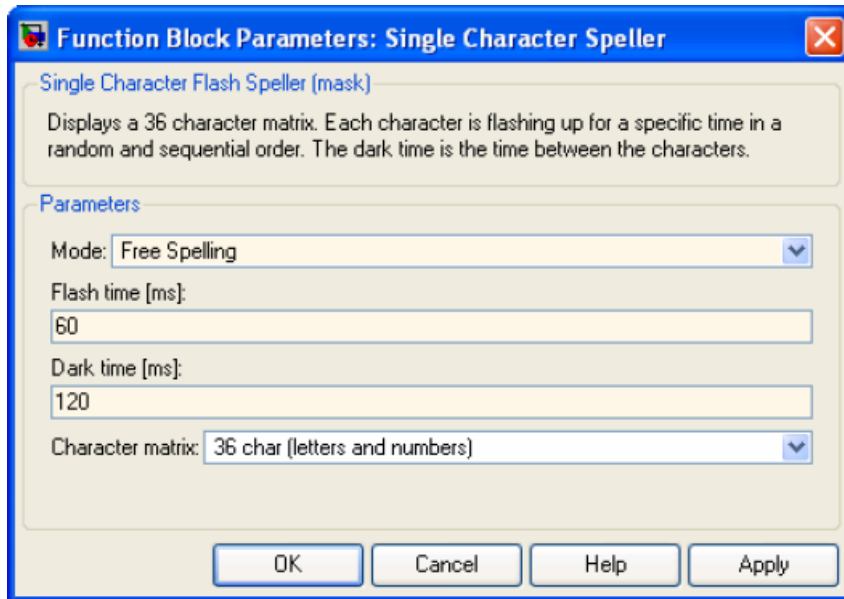

The paradigm window starts up again to flash each character in random order. The subject has to concentrate onto the specific character it wants to spell. After the selection of the **Signal Processing** unit the character is written into the paradigm window. This allows to write words without any instruction. Therefore no accuracy can be calculated.

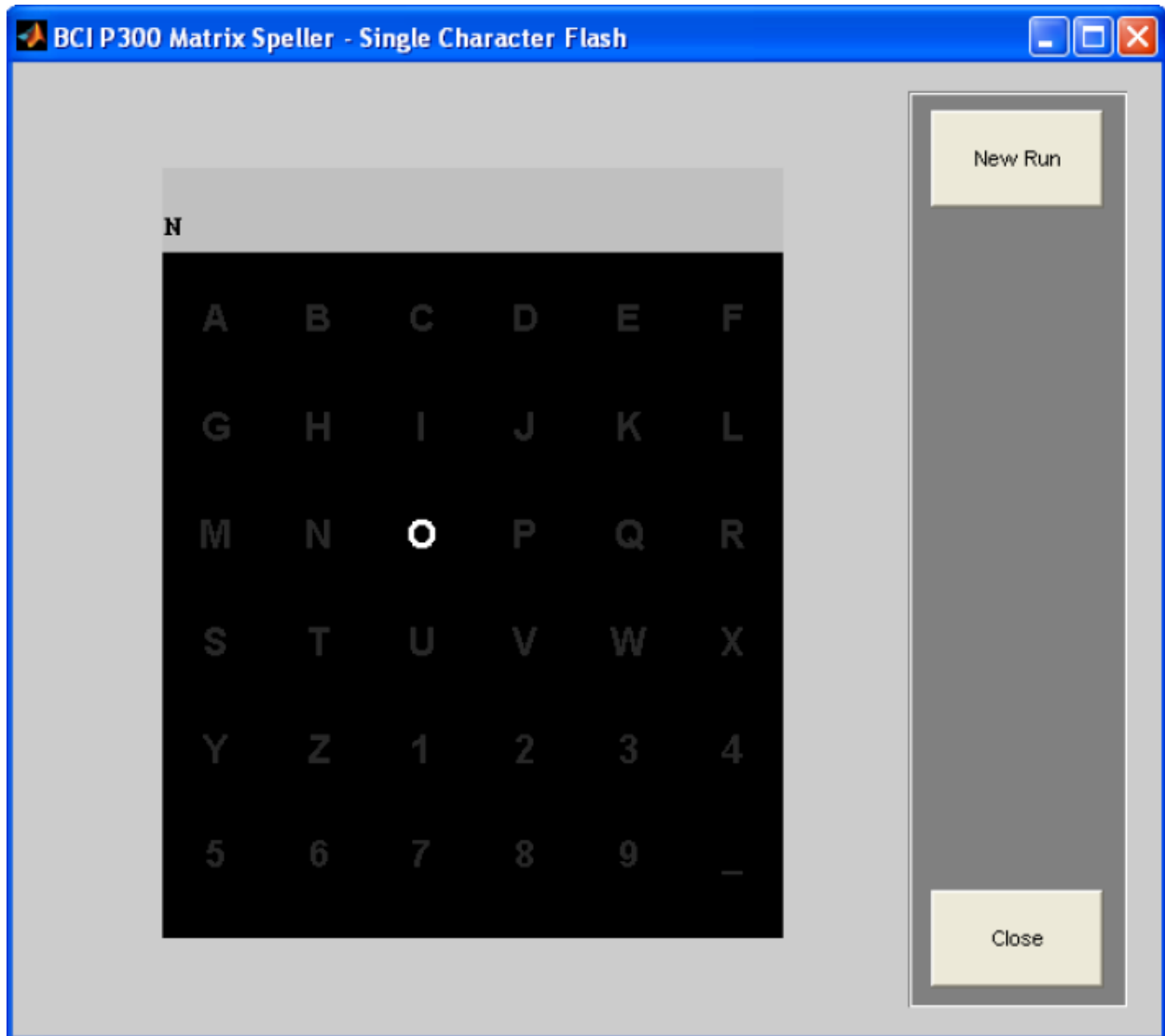

Data storage and visualization

The **Single Character Speller** block output also two signals called **Flash** and **Target**. **Flash** is the ID of the character that flashed up. **Target** is a trigger signal indicating when the letter flashed up that should be spelled in the Copy Spelling mode.

Double click onto the **Scope** block to investigate the signals:

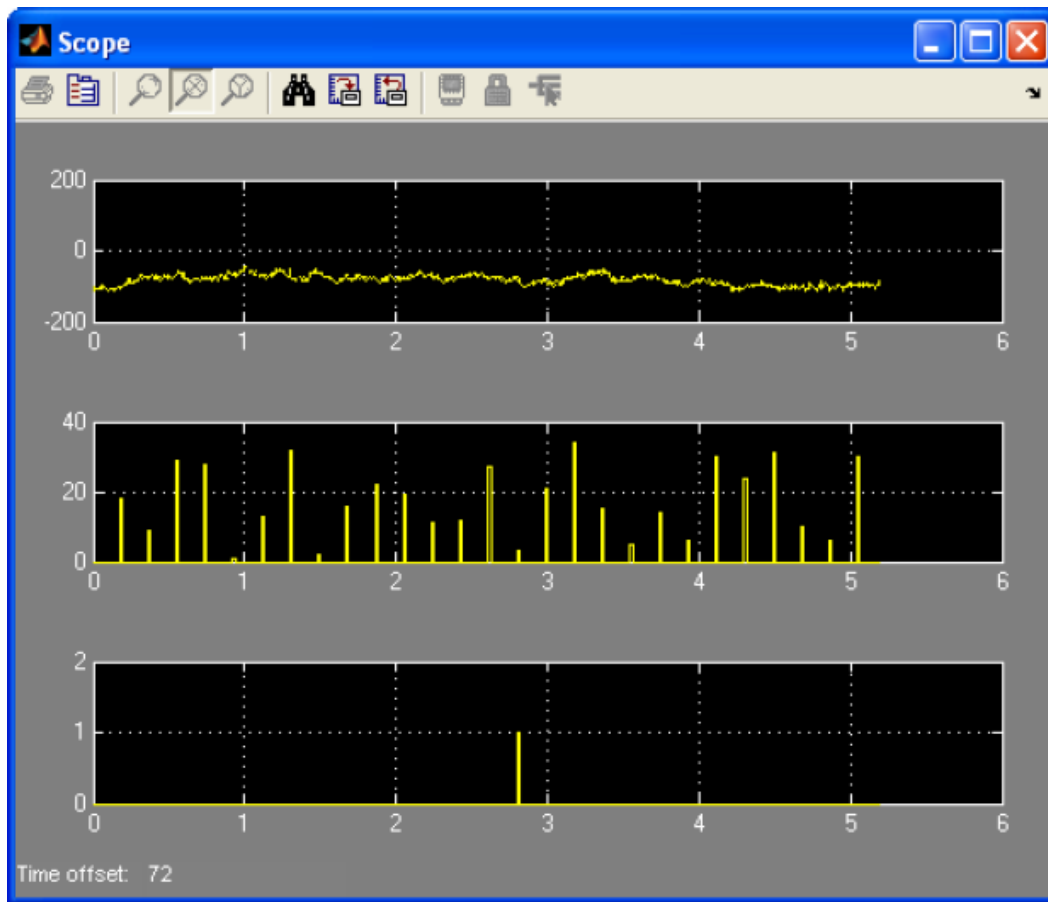

The first channel is the EEG data. The second channel contains the **ID** of the character that was flashing up and the third channel indicates the time point when the target letter was flashing up. Note that channel 2 is scaled from 0 to 40. Therefore integers 1 to 36 of the 36 characters can be displayed. Channel 3 displays 1 if the target flashed up.

The **To File** block stores the EEG data, the **Flash** and **Target** signals.

Off-line processing

Type into the MATLAB command window

```
gBSanalyze
```

to start the Data Editor.

Enter a Sampling rate of 256 Hz.

Load the acquired data file session1.mat acquired during the copy spelling mode or load the data set P300Example1.mat stored under

```
C:\Program Files\gtec\gtechS\Examples\COMMON
```

for the calculation of the P300 potentials.

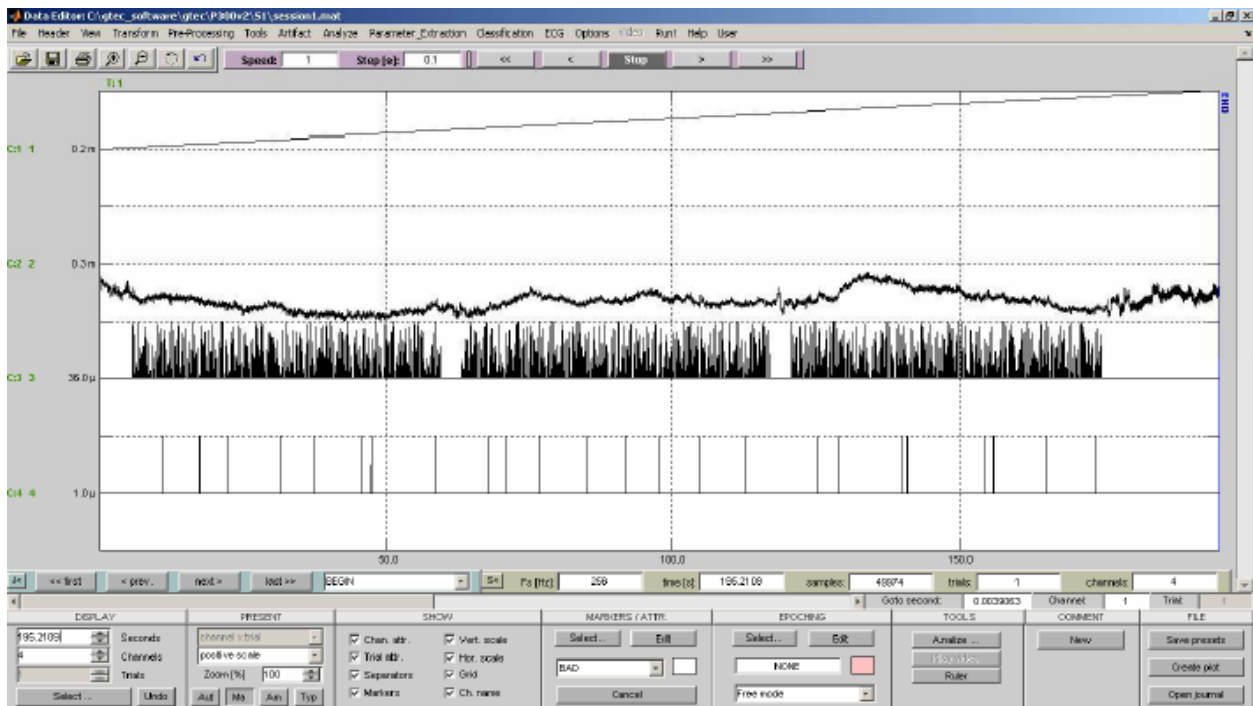

Channel 1 contains a time stamp of each sample stored. Channel 2 contains the EEG signal. Channel 3 displays the **Flash-ID** of the three characters (3 blocks of 36 numbers). Channel 4 displays the time point when the target character was flashing up (3 characters with 8 flashes each).

Select **Appearance Settings** from the **Options** menu and set the **USER DIRECTORY** to

```
C:\Program Files\gtec\gtechS\Examples\COMMON\Batch
```

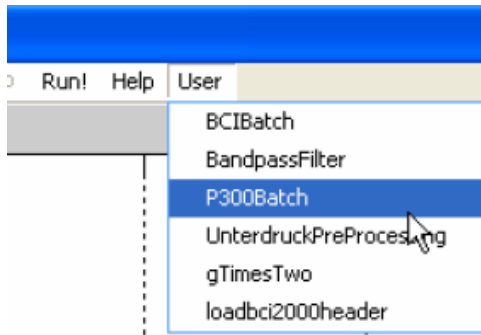

Go to the **User** menu in g.BSanalyze and select the P300batch.



The Batch extracts EEG data of a window beginning 100 ms before and ending 700 ms after each character flash. Then the trials are split into non-target and target characters.

gResult2D opens with the P300 average time course of the target characters: If 3 characters with 8 flashes each were recorded then 24 trials are averaged. The time to spell one character is calculated according to the following equation:

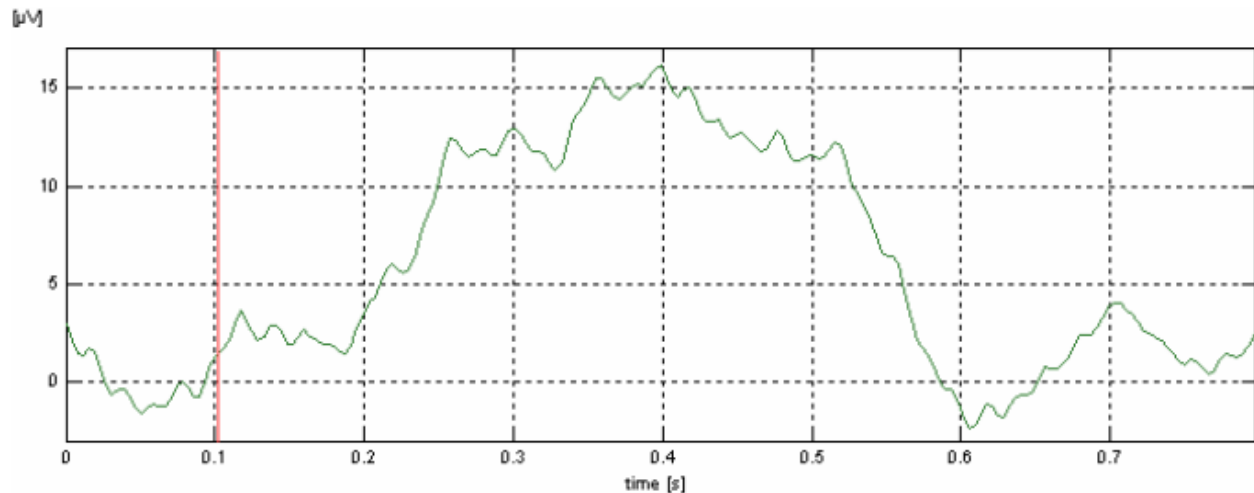
$$\text{Time per character} = (\text{Flash time} + \text{Dark time}) * \text{Number of characters} * \text{Number of flashes} = (60 \text{ ms} + 120 \text{ ms}) * 36 * 8 = 51.84 \text{ sec}$$



Then gResult2D opens also the P300 average time course of all non-target characters. If 3 characters were spelled, each flashing 8 times, on a 36 character matrix then 864 characters were flashing in total. In order to subtract the target trials the inverted EEG trials of the target flashes were added. This yields to $864 + 24 = 888$ trials.

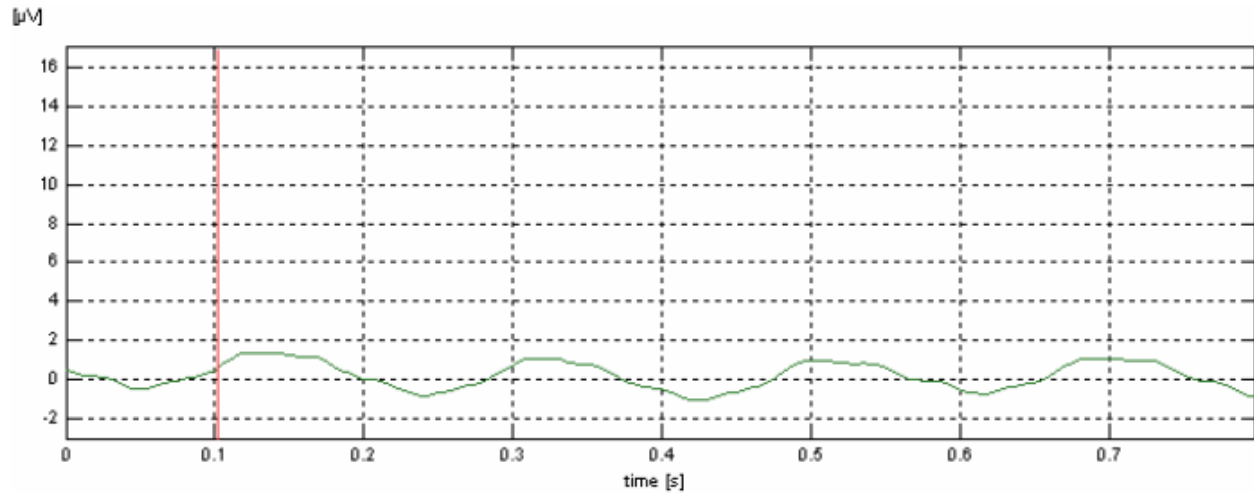

Change the **Dark Time** to 40 ms, the **Number of Flashes** to 10 and store data under `session2.mat`. Then **Start** again the Simulink model and spell GTEC in copy spelling.

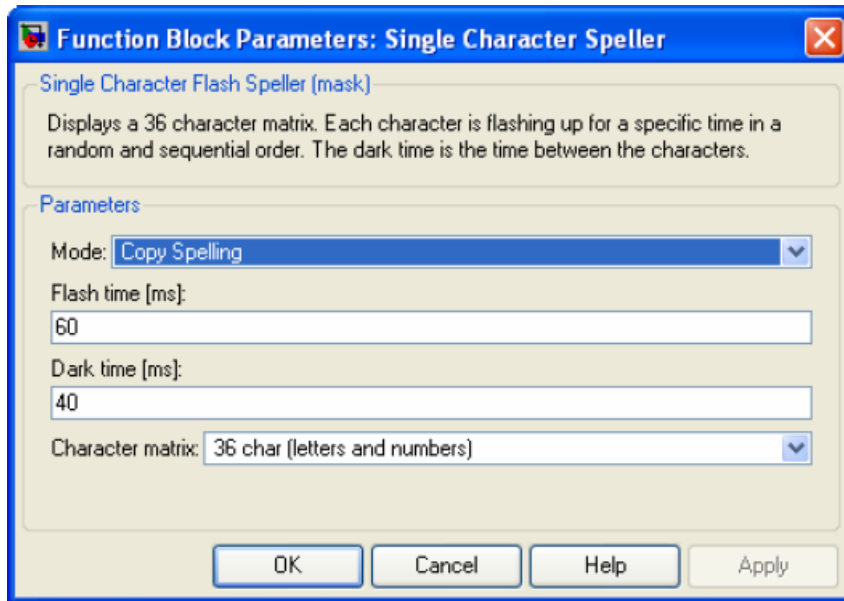

This will yield to $100 \text{ ms} * 36 * 10 = 36 \text{ sec}$ per character.

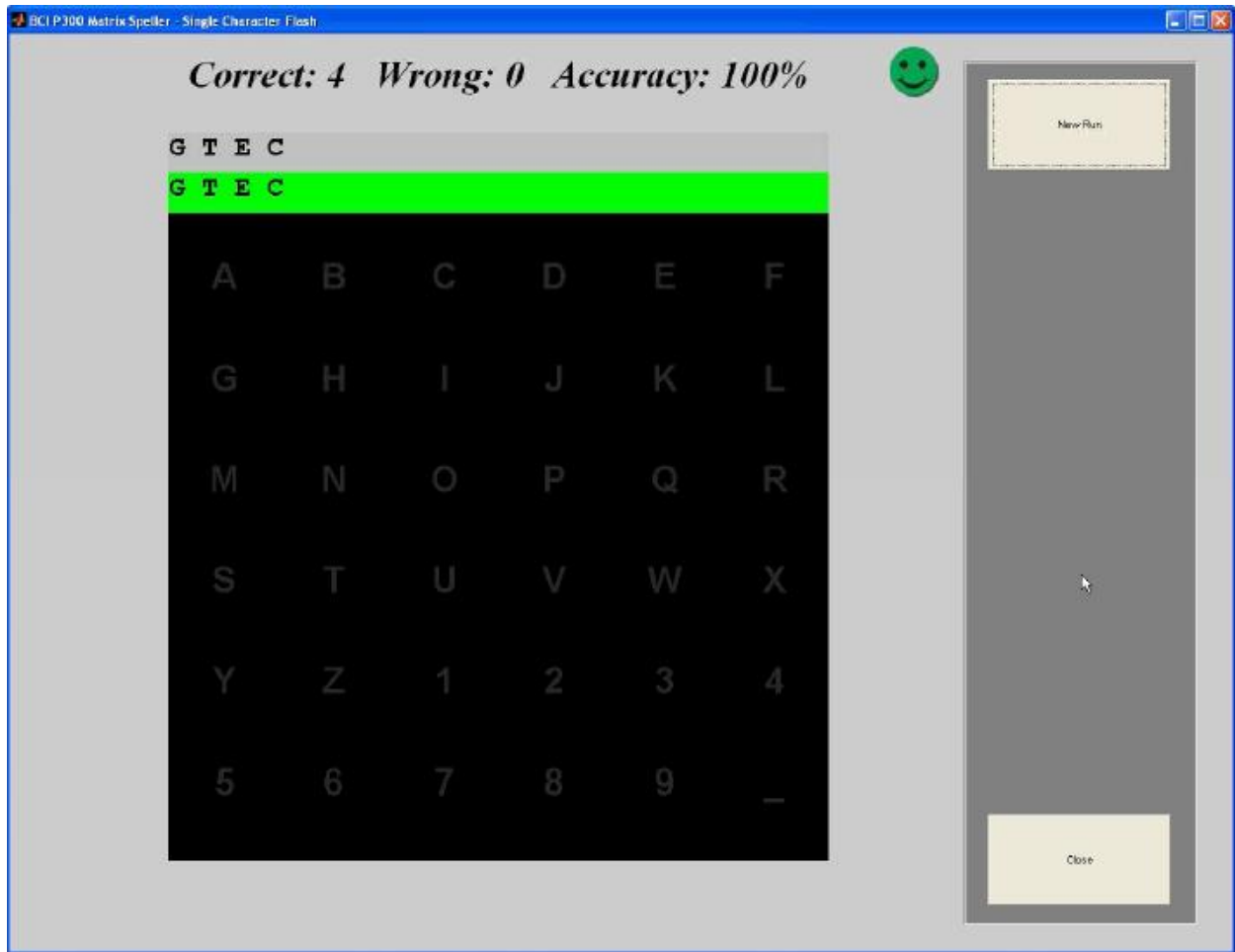

Load the recorded data set session2.mat or load the data set P300Example2.mat stored under
C:\Program Files\gtec\gtechS\Examples\COMMON
into the Data Editor.

Then start again the P300Batch from the **User** menu of the Data Editor.

gResult2D opens with the P300 component of all 40 target trials (4 characters * 10 flashes).

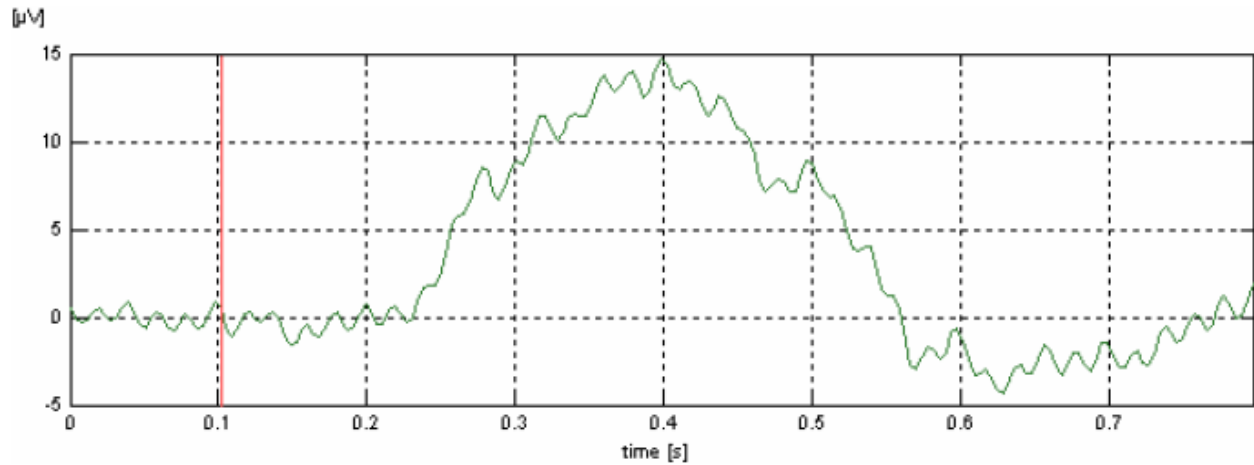

and with the averaged 1480 non target trials:

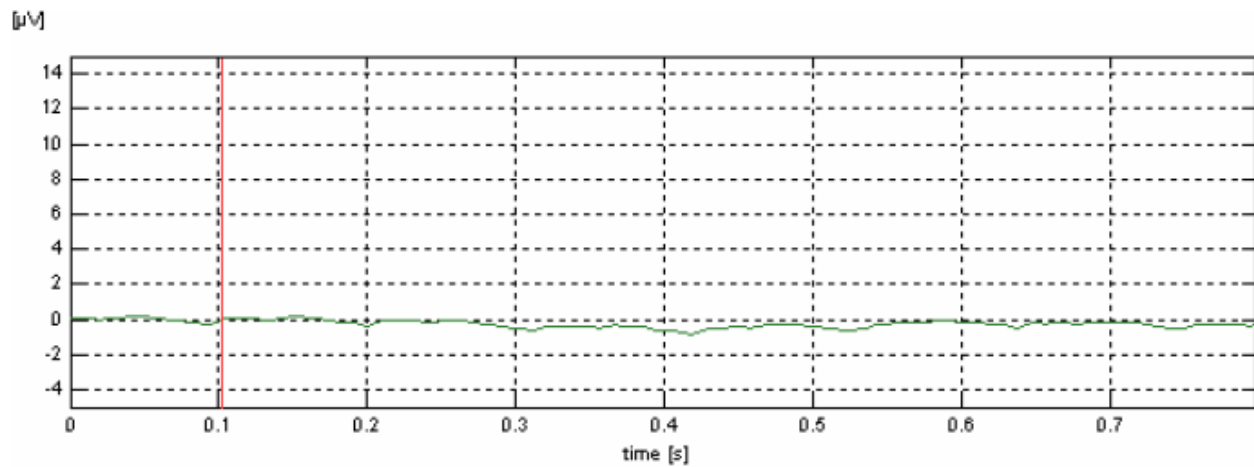

In order to further improve the speed enter **Number of flashes 6** in the **Signal Processing** window.

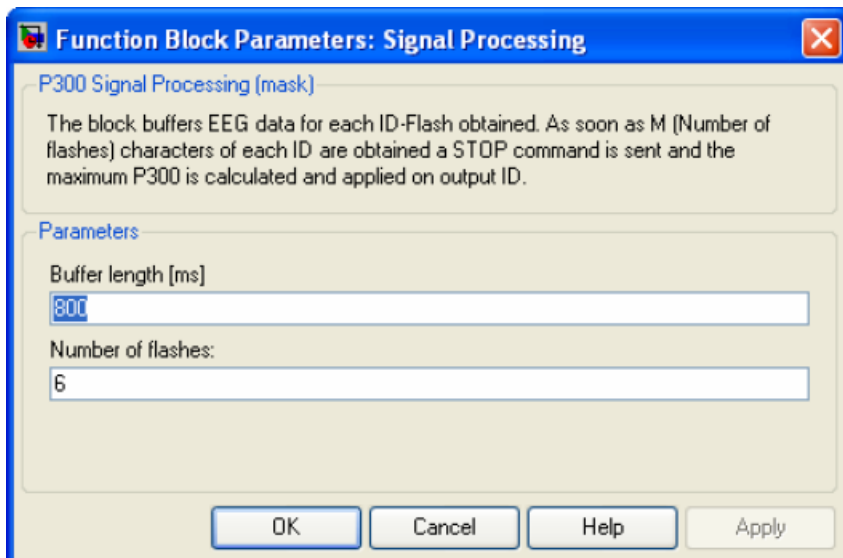

Set the **Flash time** to 50 ms and the **Dark time** to 20 ms in the **Single Character Speller** window.

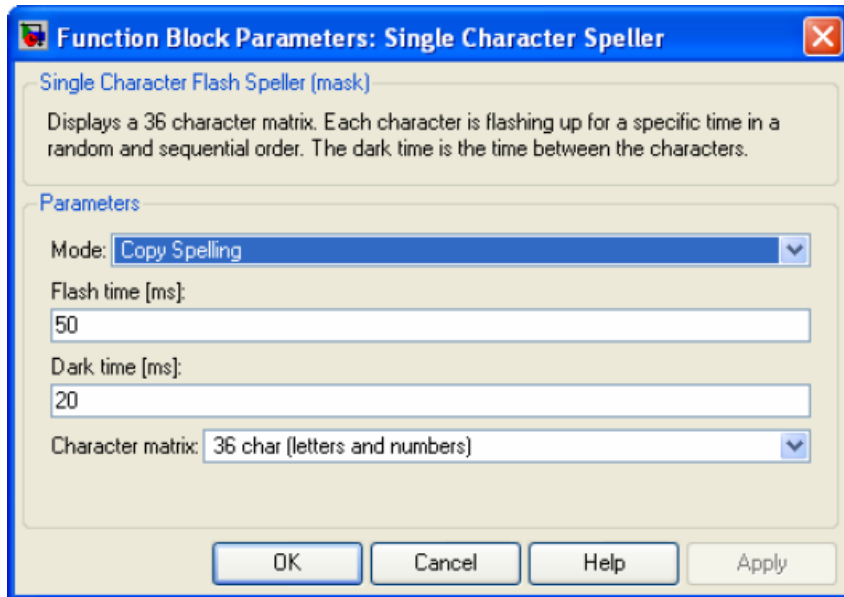

Select the copy spell mode, store the data under session3.mat and enter the word BCI. Then **Start** the Simulink model.

This gives

$(50 \text{ ms} + 20 \text{ ms}) * 36 * 6 = 15.12 \text{ sec per character.}$

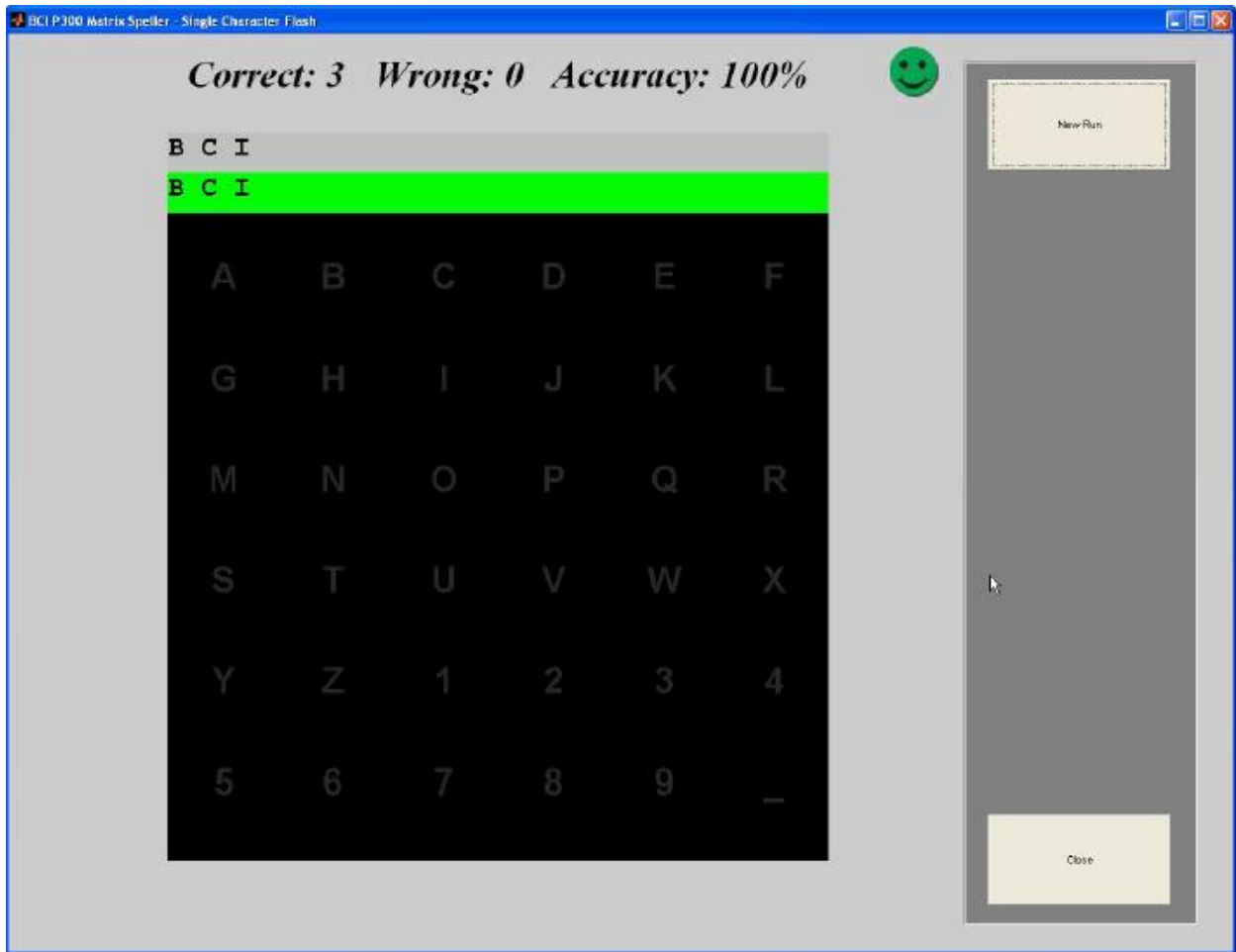

Load the data set recorded session3.mat or open the already stored data set P300Example3.mat under

C:\Program Files\gtec\gtechS\Examples\COMMON

The 18 averaged target trials give:

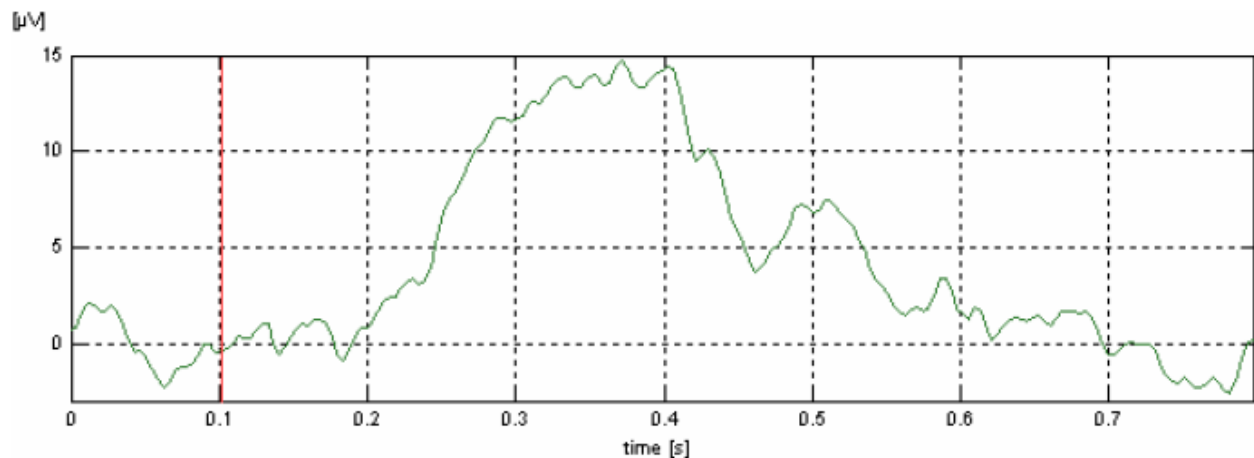

The non target trials result in:

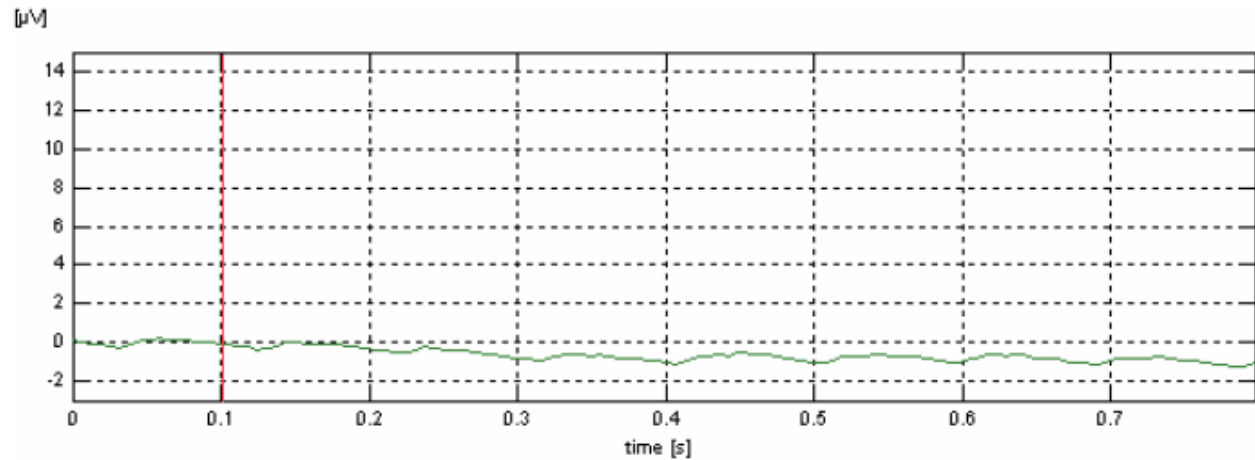

Summary

The new Simulink Highspeed On-line Processing block g.MOBIIab+ allows to setup a P300 Single Character Flash Speller. Important is that the **Signal Processing** block is communicating over a well defined communication channel with the **Single Character Flash** paradigm. Therefore the Signal Processing is independent from the paradigm and can be replaced by other algorithms. The same is the case for the paradigm block.



contact information

g.tec medical engineering GmbH
Sierningstrasse 14
4521 Schiedlberg
Austria

tel. +43 7251 22240
fax. +43 7251 22240 39
web: www.gtec.at
e-mail: office@gtec.at